

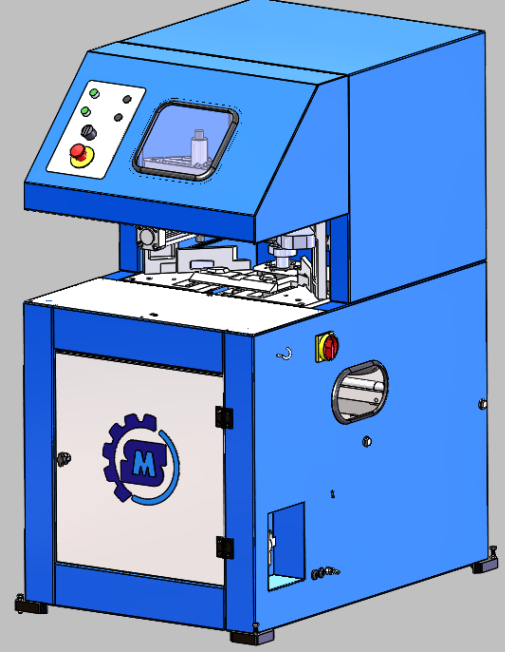

SÖNMEZ MACHINE / KT 504.2

# KT 504.2

## OTOMATİK KÖŞE TEMİZLEME MAKİNESİ



### OTOMATİK KÖŞE TEMİZLEME MAKİNASI (2 BIÇAKLI)

- Plastik profillerin kaynak sonrası köşe ve yüzey temizleme işlemleri için kullanılır.
- Özel alımlı alüminyum tabla, güçlü sac kabin, uzun ömürlü elektrostatik boya
- Pnömatik hareket, otomatik çalışma sistemi
- İşlemin otomatik olarak başlangıç noktasına dönüş özelliği
- Makinenin çalışmasını önleyen emniyetli arka kapak switchi
- Profillerin 45° gönyeye düzgün oturmasını sağlayan merkezleme sistemi
- Bıçakları çıkartmadan 2 ayrı profilin işlemi için otomatik bıçak seçme özelliği
- Profilin çeşidine göre mengeneri otomatik olarak sabitleme işlemi
- Zemine göre ayarlanabilen ve titreşimi izole eden kabin lastikleri
- CE normlarına uygun tasarım

CE ISO-EN 9001:2000







SÖNMEZ MACHINE LTD. ŞTİ.

Adres : KAYAPA ORGANİZE SANAYİ BÖLGESİ LALE CADDESİ NO: 14 NİLÜFER/BURSA/TÜRKİYE  
Tel: +90 224 367 33 04 / 367 04 41  
Fax: +90 224 3670049  
Mobil : +90 555 277 71 77  
Web : [www.somakpvc.com](http://www.somakpvc.com)  
e-mail : [export@somakpvc.com](mailto:export@somakpvc.com)

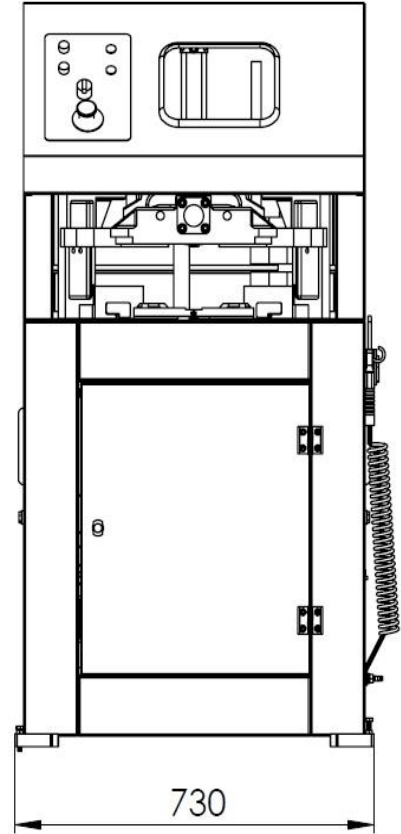
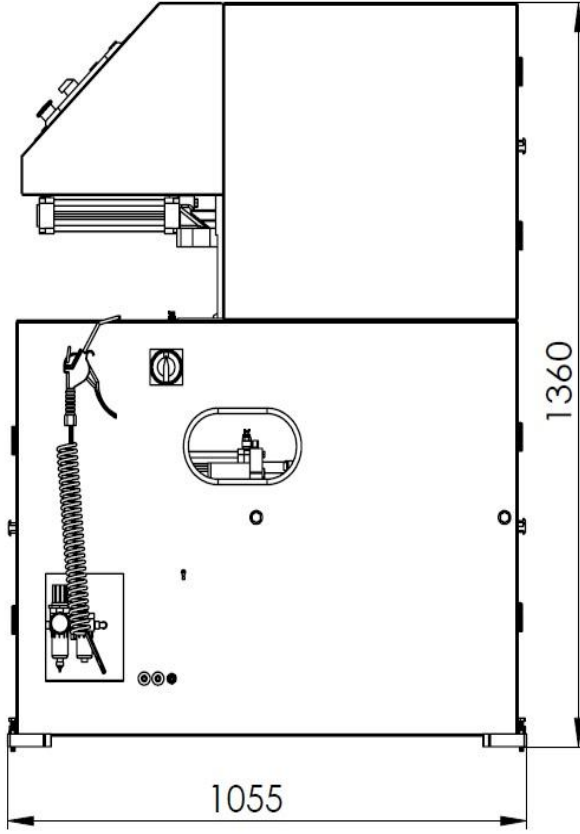

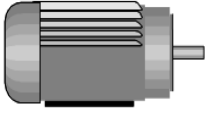
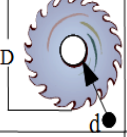
SÖNMEZ MACHINE / KT 504.2

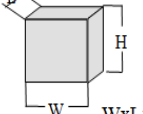

TEKNİKÖZELLİKLER TECHNICAL FEATURES							
				BAR	Hava tüke. Air cons.		
<b>KT-504-4</b> <b>KT-504-2</b>	0,55KW-3000DD	D:115 D:200	3000 D/dak. RPM	6-8	40 Lt./dak. Lt./min	73x105x140	120 kg

SÖNMEZ MACHINE LTD. ŞTİ.

Adres : KAYAPA ORGANİZE SANAYİ BÖLGESİ LALE CADDESİ NO: 14 NİLÜFER/BURSA/TÜRKİYE  
Tel: +90 224 367 33 04 / 367 04 41  
Fax: +90 224 3670049  
Mobil : +90 555 277 71 77  
Web : [www.somakpvc.com](http://www.somakpvc.com)  
e-mail : [export@somakpvc.com](mailto:export@somakpvc.com)

